

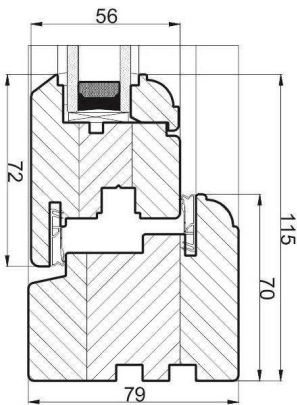

The outward opening **STORMPROOF CASEMENT** is the most frequently chosen timber window design in the UK. The profile is reflecting a proven ability to withstand exposure to adverse weather conditions. Internally glazed with a modern concealed multi point locking system the design provides high security features compliant with Secured by Design conditions. The sash stands proud of the frame giving excellent gasket compression and the best weather rating available.

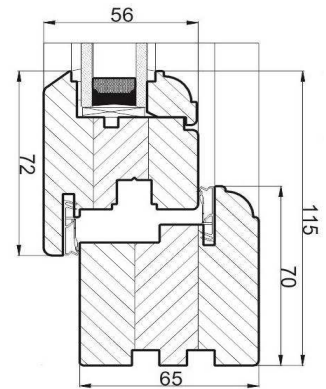

The **INLINE CASEMENT** is specifically designed to replicate a period window whilst incorporating the latest modern operation and security features. Often referred to as a conservation window, the design is characterised by a sash that sits within the frame to create a flush finish externally, the perfect choice for listed properties.

The **SLIDING SASH SPIRAL BALANCE** window or tensioned spring provides the mechanism of lift to the system. Predominantly used in new build construction, it provides a cost effective solution to this style whilst retaining all the unique features of a sash window.

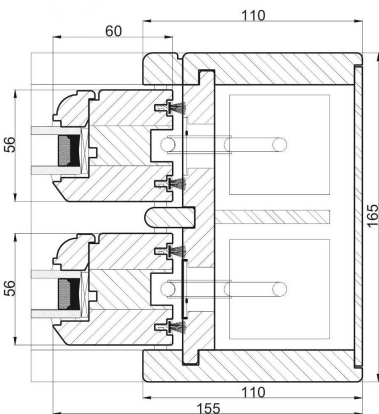
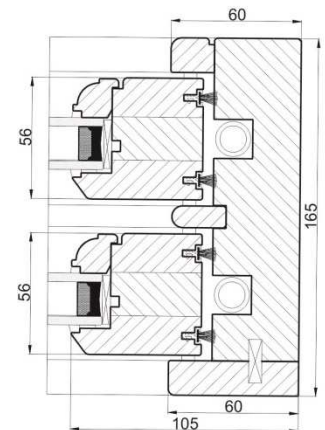

The **SLIDING SASH CORDS & WEIGHTS** window utilises pulleys and weights as the lift system. Primarily used when build circumstances dictate or when conservation requirements are a consideration. Ensuring the character and charm of the building is maintained whilst incorporating modern technologies, security and performance.



The **STORMPROOF DOOR** as a stormproof casement are resistant to changing weather condition. Door could have single or double leaf configuration. Ideal for use in conservatories, sunrooms and garden rooms, where maximum naturallight is required. Supplied as standard, multi point espagnolette locking provides the safest locking system for your door.

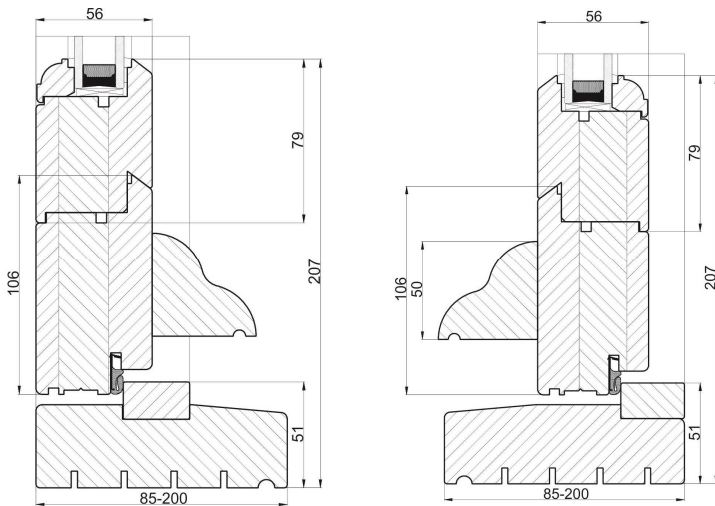
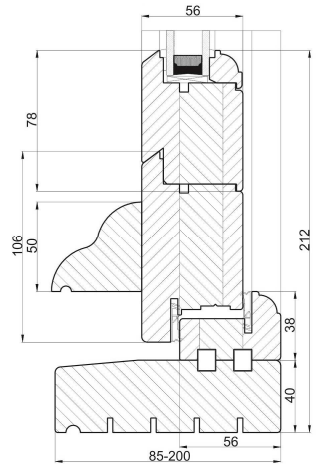

The perfect way to introduce maximum light into any room give you a **INLINE DOOR**. This door can be designed to incorporate a number of single and double door leaf configurations. Flush finish sash with double handle and high security espagnolette locking system give You maximum safety.

The **BI-FOLD DOORS** are without doubt the new vogue. Folding doors open and close effortlessly and stack unobtrusively to create wide open vistas and bringing us closer to nature. This design offers the ideal solution for creating large glazing areas with minimal timber allowing for uninterrupted views to be enjoyed from a property.

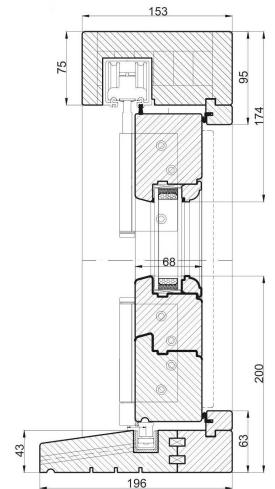

All products are made to individual specification and sizes, giving you the customer the choices you want to make windows and doors part of your home. One of the benefits of timber is its flexibility as a material. This, in combination with numerous options on the product specification enables you to design your window of choice.

**Lead time** is the most shorter than ever been, our production is in accordance with the needs of the customer. Each new products can be add permanent to our offer.

BAKO Bartnik Kowalczyk Spółka Jawna  
ul. 4 Sierpnia 4C  
16-411 Szypliszki  
PL8442352616

www: [www.bako-okna.pl](http://www.bako-okna.pl)  
e-mail: [biuro@bako-okna.pl](mailto:biuro@bako-okna.pl)  
tel. +48 875657139  
fax. +48 875657139